

# LED – RGB SAU – Light controller



<b>Table of contents</b>	<b>page</b>
1. Instructions for the manual.....	3
1.1 Validity .....	3
1.2 Target group .....	3
1.3 Storage of the manual.....	3
1.4 Further information .....	3
1.5 Used symbols .....	3
2. Safety .....	4
2.1 Technical safety advices.....	4
2.2 Use in accordance with regulations .....	5
3. Delivery .....	5
4. Function .....	6
4.1 Light programmes.....	6
5. Operation .....	6
6. Technical description.....	6
6.1 Measures / Weight .....	6
6.2 Electrics.....	6
7. Installation .....	7
7.1 Requirements to the place of installation .....	8
7.2 Electrical connection.....	8
8. Taking into operation .....	9
9. Taking out of operation .....	9
10. Maintenance.....	9
11. Trouble sooting .....	9
12. Wiring diagramme .....	10
12.1 External control .....	11
13. Spare parts .....	11
14. Contact .....	12

## 1. Instructions for the manual

### 1.1 Validity

This manual describes the installation, taking into operation and operation of the unit.

### 1.2 Target group

Only instructed people are allowed to operate the unit. Connection works can only be done by qualified craftsmen.



### 1.3 Storage of the manual

The manual has to be stored in the direct surrounding of the installed unit. It has always to be accessible.

### 1.4 Further information

For further information please contact [WDT](#).







### 1.5 Used symbols

	<p><b>Attention!</b> Warning of danger!</p> <p>Failure to observe this warning may result in serious injury or death and/or damage to the unit</p> <p><b>Every explanation of this sign has to be considered!</b></p>
	<p><b>Attention!</b> Warning of hazardous electrical voltage!</p> <p><b>Danger, Hazardous Voltage:</b> Hazardous electrical current! Failure to observe this warning may result in injury or even serious injury or death.</p> <p><b>Every explanation of this sign has to be considered!</b></p>
	<p><b>Advise!</b></p> <p>This sign refers to circumstances that can affect the functioning of the unit in a positive as well as in a negative way.</p>

## 2. Safety

### 2.1 Technical safety advices

WDT does not take the liability for damages that occur due to not considering this manual. The easy and safe operation of the unit assumes a correct transport, storage and installation of the unit. Respect the following advices to minimize the risk in injury or even serious injury or death.

	<p>The installation of the unit has to be done in accordance with the safety norms (e.g. DIN/ VDE) and all other relevant governmental norms and laws.</p> <p>During the operation all covers of the unit have to be closed.</p> <p>Disconnect unit components from power supply prior to maintenance or repair work.</p>
 	<p><b>General</b></p> <p>Obey all safety notes and warnings present on the unit. In case of a malfunction, switch off the unit immediately and prevent a restart. Repair malfunctions promptly. After any repair work, have qualified personnel check the safe operation of the unit. Use original spare parts only. Additional national safety regulations also fully apply to the operation of this unit.</p>
	<p><b>Accident Prevention Regulations</b></p> <p>Comply with the accident prevention regulation Accident Prevention Regulation Electrical Systems and Equipment (VBG4/BGVA2) to prevent injury to yourself and others.</p>
	<p><b>Operation of the Unit</b></p> <p>Do not perform any work which compromises the safety of the unit. Regularly check that all safety and monitoring devices are functioning normally. Do not remove or disable safety devices.</p>
	<p><b>Installation, Dismantling, Maintenance and Repair of the Unit</b></p> <p>Disconnect unit components from power supply prior to maintenance or repair work. Attaching or installing <b>additional components</b> is permitted only with the <b>consent</b> of the manufacturer.</p> <p><b>Work on the electrical system</b> must be performed by qualified personnel. Disconnect unit components from power supply prior to work. In case of a malfunction in the electrical power supply, switch off the unit immediately. Use only original fuses with the appropriate amperage rating.</p>

## **2.2 Use in accordance with regulations**

The unit is only designed for the operation in the described use. Other fields of use are not allowed.

## **3. Delivery**

- Please look after transport damage when the unit arrived.
- Do not let the goods fall down, do not throw the goods .....!
- Open package carefully!



**Note:** The operator is responsible for the disposal of unit components as required by law.

## 4. Function

Light controller LED-RGB-WDT-SAU for 1 – 10 3x1W LED RGB spots. The controller can realize six static colours and nine light programmes (see point 4.1). The setting of the light programmes is done by a code switch. Optionally the light controller can be controlled externally by a four-digit digital-Code. If more than 10 spots are required the controller can be extended by a Slave controller that is connected to the Master by a data BUS cable.

### 4.1 Light programmes

0	Off	8	Red-Green-Blue colour change
1	White	9	Red-Green-Blue colour change slow
2	Blue	10	Yellow
3	Red	11	Magenta
4	Red-Green colour change	12	Lively Orange-Yellow-Green
5	Green	13	Calming Red- Turquoise-Blue- Purple
6	Blue-Green colour change	14	Blue shade colour change
7	Flashlights	15	Mix colour change

## 5. Operation

The controller (only the Master model) has a rotary switch with the positions 1-15. This switch is to choose one of the above light programs. Every time the unit is supplied with power, the adjusted light programme starts.

With a serial cable you can connect an external controller instead of the rotary switch to choose the programmes. This controller has to give for non-volt contacts. If all contact are closed the light is white (see point 12.1).

## 6. Technical description

### 6.1 Measures / Weight

- Width: 130mm
- Height: 180mm
- Depth: 90mm
- Weight: 1,5Kg

### 6.2 Electrics

- Power supply: 230V/AC 0,5A
- Operation voltage: 30V/AC max. Stromstärke von 350mA
- Fusing: 3,15At- 30VAC

## 7. Installation

**Attention: Installation and work on the electrical system** must be performed by qualified personnel. Disconnect unit components from power supply prior to work. Read the manual before the installation.

Installation schema of the controller with 2 LED Spots.

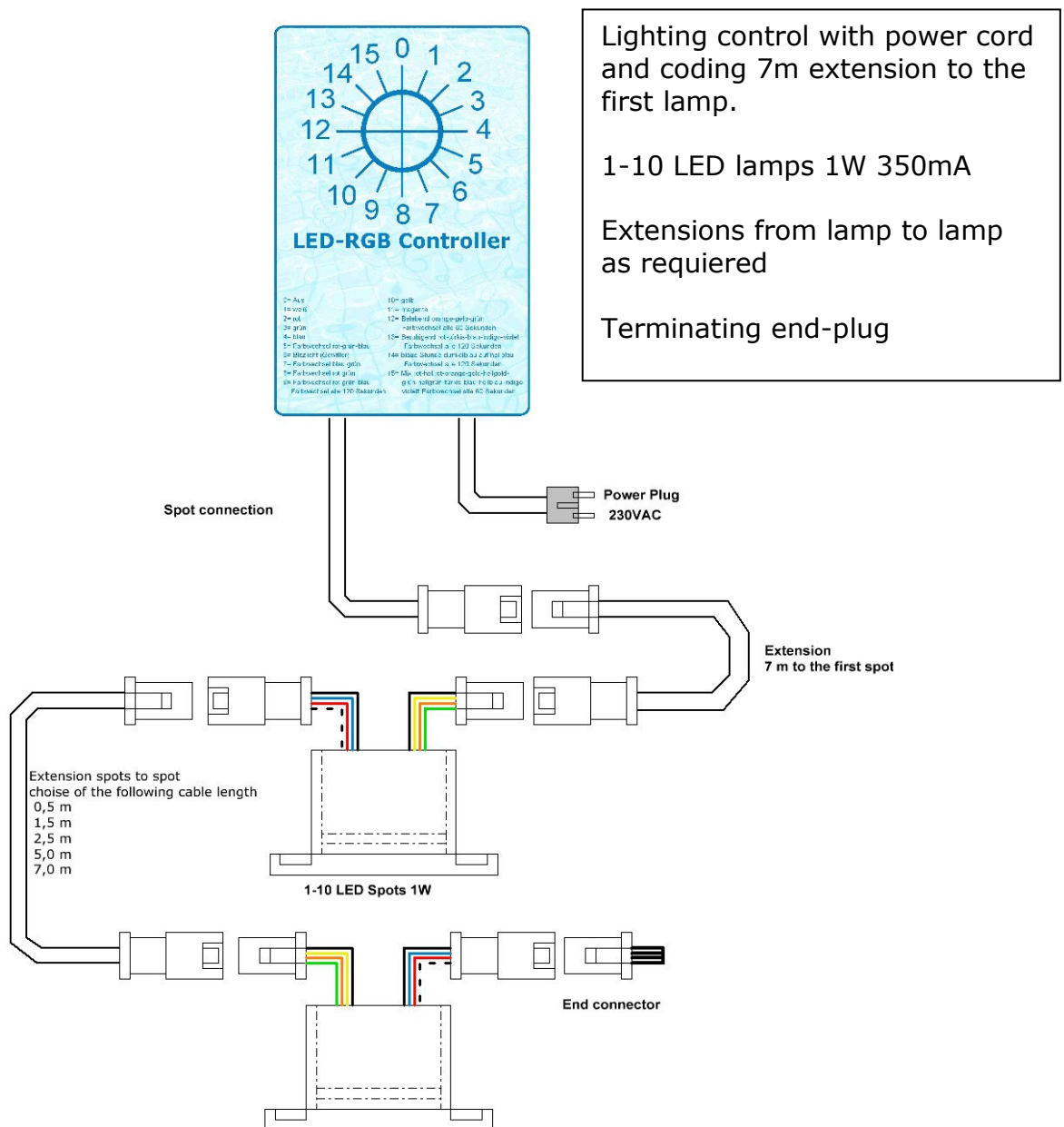

Installation schema with three controller (1 Master and 2 Slave) connected by a data BUS cable:

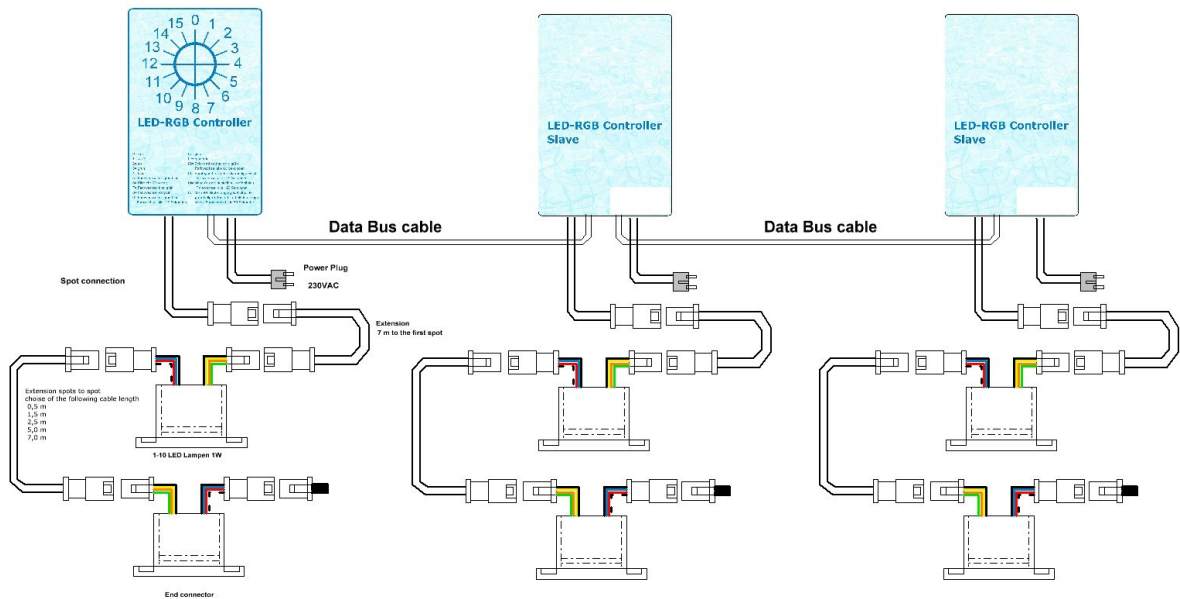

## 7.1 Requirements to the place of installation



- The controller has to be installed at an easy accessible place.
- The temperature there should be between +5 and +40 °C.
- The humidity should not be higher than 80%.

## 7.2 Electrical connection

- 230V/AC connection cable
- BUS cable with connector. 1m Standard. Other length has to be ordered seperately.
- Up to 2m a not screened/ unshielded cable is sufficient if the cable is installed separately (not together with voltage leading cables).
- Max. length of the cable is 30m with screened/ shielded cable and seperate installation.



## 8. Taking into operation

	<p><b>Achtung:</b> Work on the electrical system must be performed by qualified personnel. Disconnect unit components from power supply prior to work.</p>
	<p><b>Attention</b> Max 10 spots can be connected to one controller.</p>

Please check the wiring again after the installation. Ensure that all covers / lids are mounted. Only now the voltage supply shall be switched-on. Now test all programmes on their correct function by the rotary knob.

## 9. Taking out of operation

Disconnect the controller from the voltage supply before you take it out of operation.

## 10. Maintenance

As the controller consists only of electrical and electronic components the maintenance is reduced on the function control and the cleaning of the housing and the spots.

## 11. Trouble shooting

	<p><b>Attention: Installation and work on the electrical system</b> must be performed by qualified personnel. Disconnect unit components from power supply prior to work. Read the manual before the installation.</p>
---	--

**Fehler:** Light does not shine.

- 1) Check the voltage supply.
- 2) Check the low voltage at the output of the transformer 30VAC.
- 3) Check the wiring.
- 4) Check the fuses.
- 5) Is the end connector on?

## 12. Wiring diagramme

You find a wiring diagramme in every control housing.

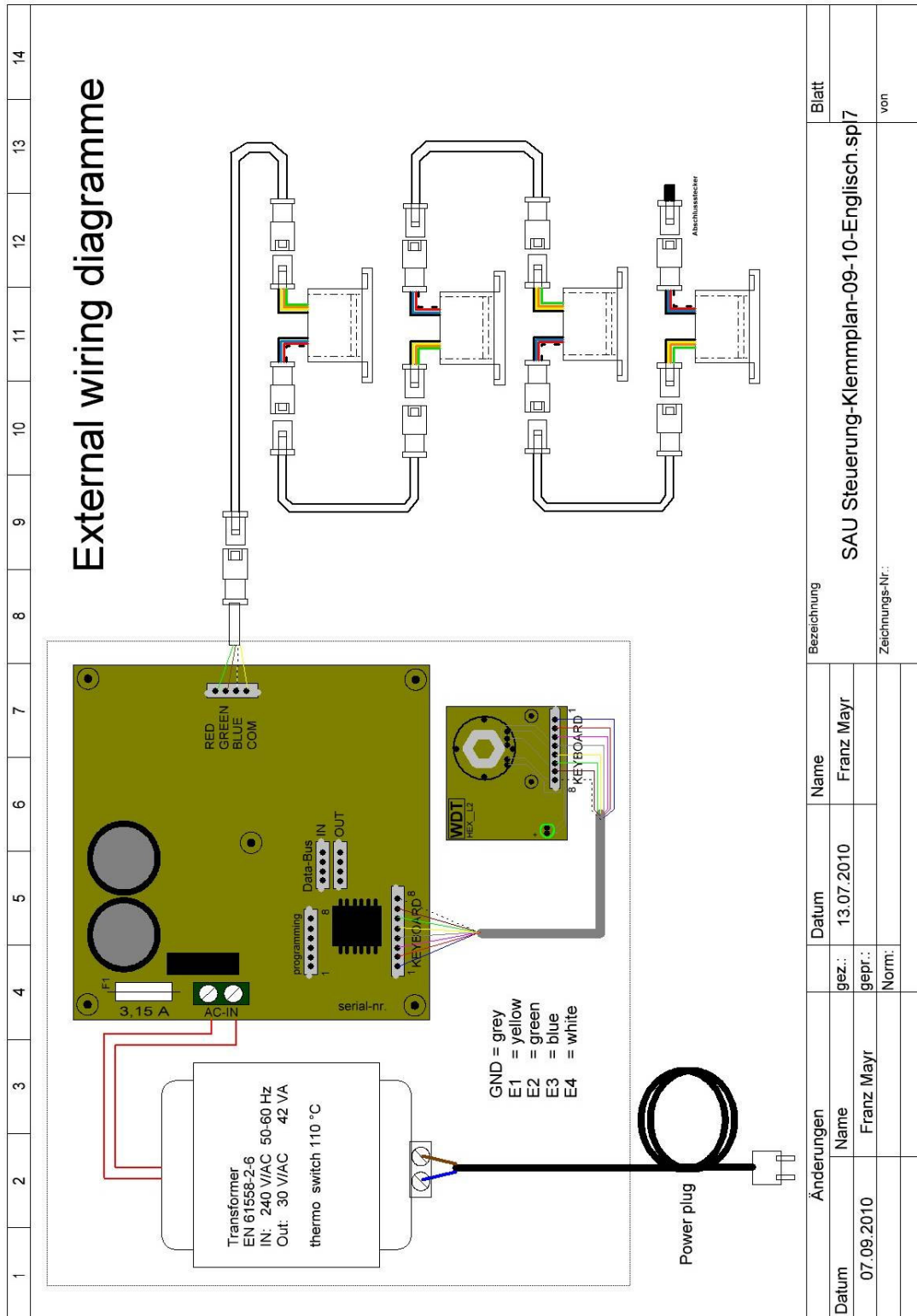

## 12.1 External control

The control of the lights is done by a code switch. The code switch gives a 4 digit digital-Code. This code is proceeded by the controller and the according light programme is started.

	E1	E2	E3	E4	SAU
0	1	1	1	1	Off
1	0	0	0	0	White
2	1	0	0	0	Blue
3	0	1	0	0	Red
4	1	1	0	0	Red-Green colour change
5	0	0	1	0	Green
6	1	0	1	0	Blue-Green colour change
7	0	1	1	0	Flashlights
8	1	1	1	0	Red-Green-Blue colour change
9	0	0	0	1	Red-Green-Blue colour change slow
10	1	0	0	1	Yellow
11	0	1	0	1	Magenta
12	1	1	0	1	Lively
13	0	0	1	1	Calming
14	1	0	1	1	Blue shade
15	0	1	1	1	Mix

## 13. Spare parts

	Art. Nr.	Art. Text
	21590	Code switch with 16 positions, soldered on PCB
	21588	Connection cable controller code switch 2 x molex plug, 8 poles, 25 cm cable
	21203	Controller SAU RGB for 1-10 LED
	21420	Transformer, 230/30VAC 50-60Hz / 42VA
	10995	Power cable 2x0,75 2m
	21192	Cable 0,5 m with JST coupling and moplex plug 4 poles, connection LED Spots - controller
	21204	BUS cable for connection Master - Slave

## **14. Contact**

### **WDT**

Werner Dosiertechnik GmbH & Co. KG  
Hettlinger Str. 17  
D-86637 Wertingen – Geratshofen

**Tel.:** +49 (0)8272/ 98697- 0

**Fax:** +49 (0)8272/ 98697- 29

**E-Mail:** [info@werner-dosiertechnik.de](mailto:info@werner-dosiertechnik.de)

**Website:** <http://www.werner-dosiertechnik.de>